

(G614) LG-10  
Lathe Chuck Guard  
Diagram

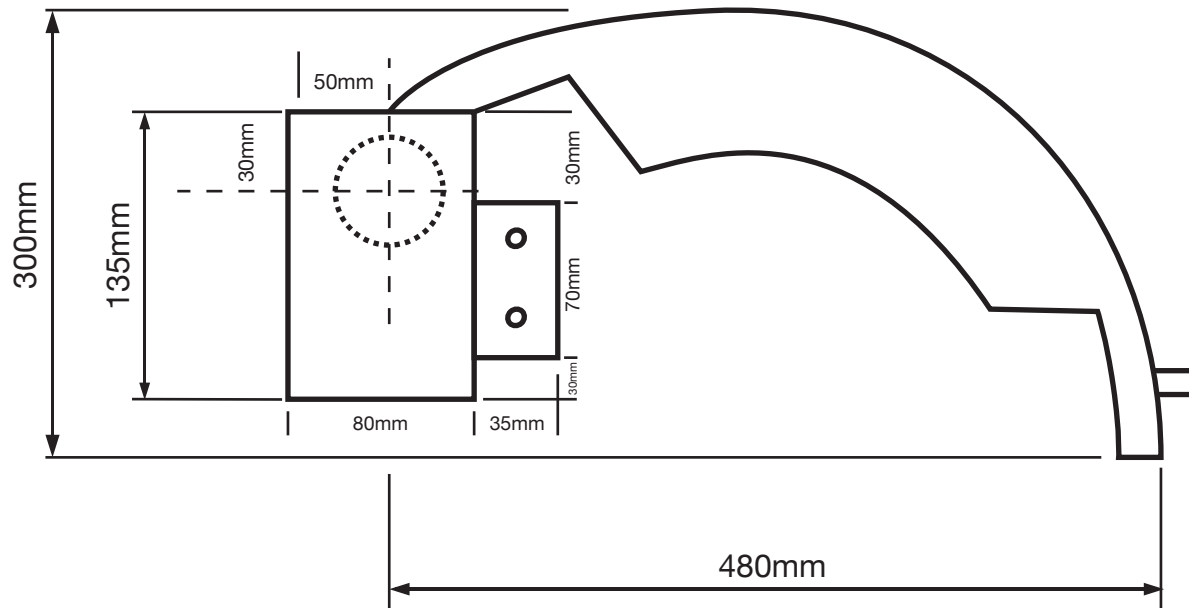
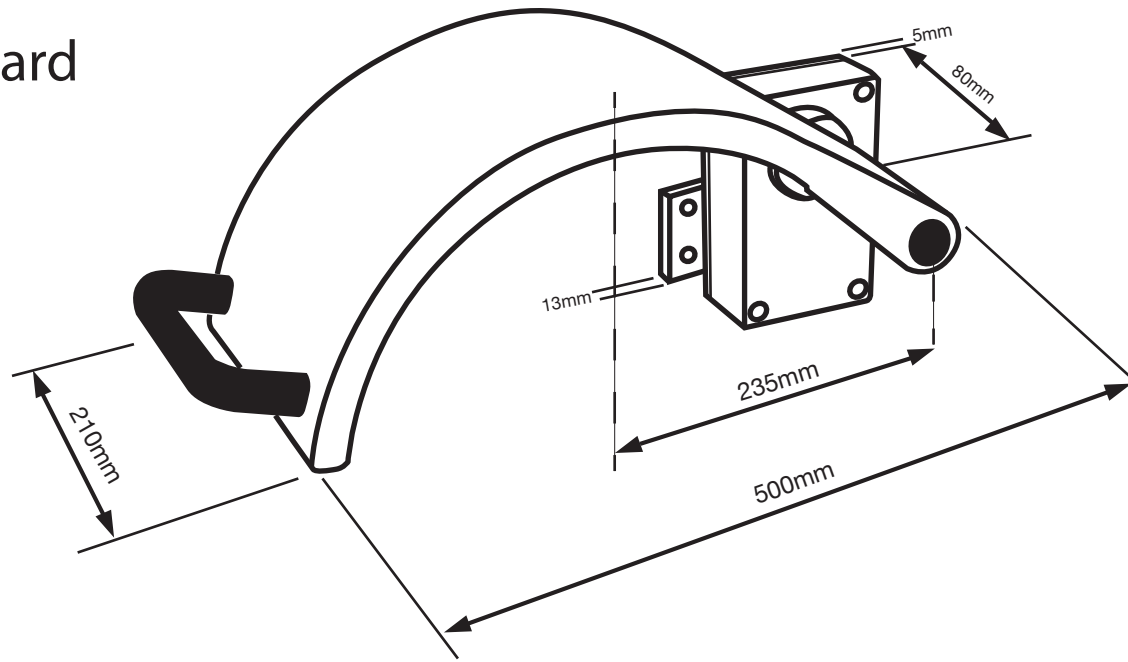

Diagram not to scale